

# *Arcair*<sup>®</sup>

## ***Air Carbon-Arc Guide***

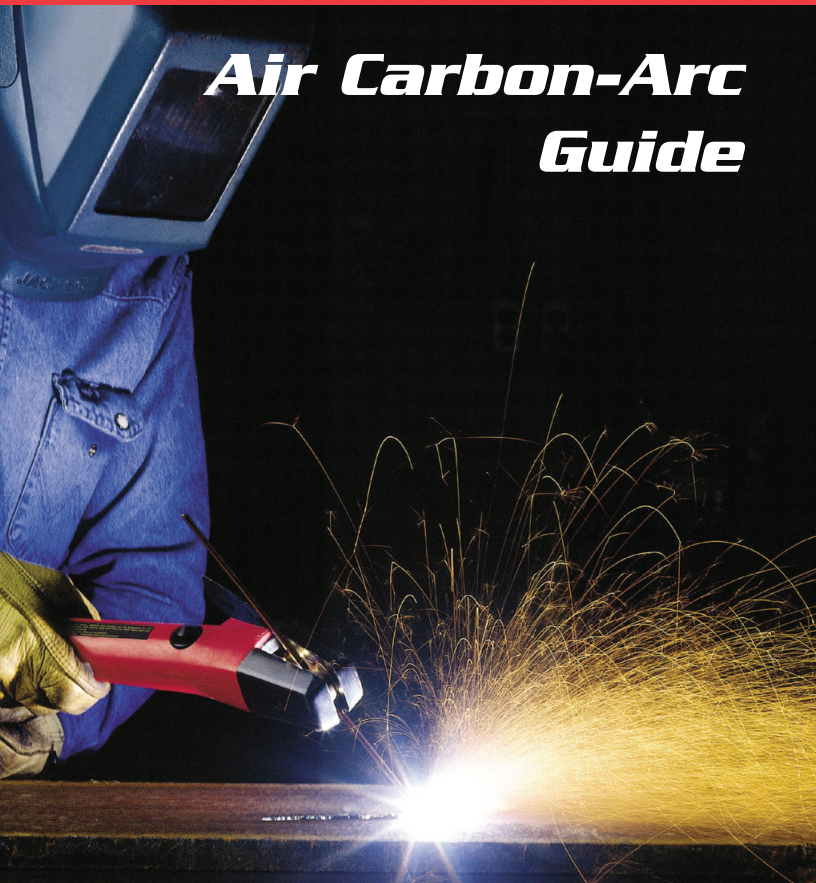

Revision: B

Issue Date: November 4, 2010

Form No: 89-250-008





# *Arcair*<sup>®</sup>

## **YOU ARE IN GOOD COMPANY!**

The Brand of Choice for Contractors and Fabricators Worldwide.

Arcair<sup>®</sup> is a Global Brand of Welding Products for Thermadyne Industries Inc. We manufacture and supply to major welding industry sectors worldwide, including: Manufacturing, Construction, Mining, Automotive, Aerospace, Engineering, Rural and DIY/Hobbyist.

We distinguish ourselves from our competition through market-leading, dependable products that have stood the test of time. We pride ourselves on technical innovation, competitive prices, excellent delivery, superior customer service and technical support, together with excellence in sales and marketing expertise.

Above all, we are committed to develop technologically advanced products to achieve a safer working environment within the welding industry.



## WARNING

---

*Read and understand this entire Guide and your employer's safety practices before installing, operating, or servicing the equipment. While the information contained in this Guide represents the Manufacturer's best judgement, the Manufacturer assumes no liability for its use.*

---

Air Carbon-Arc Guide  
Form Number: 89-250-008

Published by:  
Thermadyne Industries, Inc.  
2800 Airport Road  
Denton, Texas 76208  
(940) 566-2000  
www.thermadyne.com

Copyright © 2010 by Thermadyne Industries, Inc.  
® All rights reserved.

Reproduction of this work, in whole or in part, without written permission of the publisher is prohibited.

The publisher does not assume and hereby disclaims any liability to any party for any loss or damage caused by any error or omission in this manual, whether such error results from negligence, accident, or any other cause.

Publication Date: November 4, 2010

## Table of Contents

<b>SECTION 1: INTRODUCTION .....</b>	<b>1-4</b>
1.01 Process Description .....	1-4
1.02 History .....	1-4
1.03 Applications .....	1-5
<b>SECTION 2: SAFETY AND HEALTH.....</b>	<b>2-6</b>
<b>SECTION 3: PRINCIPLES OF OPERATION.....</b>	<b>3-12</b>
<b>SECTION 4: OPERATING TECHNIQUES.....</b>	<b>4-18</b>
<b>SECTION 5: EQUIPMENT SELECTION.....</b>	<b>5-26</b>
<b>SECTION 6: IMPORTANT PROCESS VARIABLES.....</b>	<b>6-29</b>
<b>SECTION 7: ADVANTAGES .....</b>	<b>7-34</b>
<b>SECTION 8: APPLICATIONS AND TROUBLESHOOTING .....</b>	<b>8-35</b>

## SECTION 1: INTRODUCTION

---

### 1.01 PROCESS DESCRIPTION

The air carbon-arc process (CAC-A) physically removes metal, not chemically as in oxy-fuel cutting (OFC). Gouging or cutting occurs when the intense heat of the arc between the carbon electrode and the workpiece melts part of the workpiece. Simultaneously, air passes through the arc quickly enough to blow the molten material away.

The air carbon-arc process does not require oxidation to maintain the cut, so it can gouge or cut metals that the OFC process cannot. Most common metals (e.g., carbon steel, stainless steel, many copper alloys and cast irons) can be cut using the air carbon-arc process. The metal removal rate depends on the melting rate and the air jet's efficiency in removing molten metal. In the process, the air must lift the molten metal clear of the arc before the metal solidifies.

### 1.02 HISTORY

Air carbon-arc gouging began in the 1940s, evolving from the existing carbon-arc cutting process. Myron Stepath, a welding engineer, developed air carbon-arc gouging to remove several hundred feet of flat, cracked, stainless steel weld.

Previously, carbon-arc cutting removed overhead and vertical defective welds and rivet heads. The carbon-arc melted the metal, then gravity moved the molten metal away.

Stepath reasoned that an air jet could provide the force to remove metal laying flat. So a direct-current, electrode-negative carbon-arc was tried with a second operator directing an air blast via air nozzle at the molten pool. However, this attempt was unsuccessful because the arc was more unstable than a carbon-welding arc. So, Stepath tried a direct-current, electrode-positive arc and the result was air carbon-arc gouging.

In 1948, Myron Stepath introduced the first air carbon-arc torch to the welding industry. In 1949, Stepath and two associates founded the Arcair® Company.

Now, two operators were not needed. The compressed air passed through the torch and exited beneath the electrode. This new tool saved time on weld backgouging, crack removal, and weld defect repair on carbon, alloy, and stainless steel. Previously, these tasks were performed by grinding or chipping. The basic principle remains the same today, but with improved equipment and an expanded number of applications.

### **1.03 APPLICATIONS**

The industry has enthusiastically adopted air carbon-arc gouging and found many uses for the process in metal fabrication and casting finishing, chemical and petroleum technology, construction, mining, general repair, and maintenance.

Arcair® Torches and Electrodes are used throughout the world, anywhere metal is gouged, grooved, severed, or removed from a surface.

The air carbon-arc process is flexible, efficient, and cost effective on practically any metal: carbon steel, stainless steel and other ferrous alloys; gray, malleable and ductile iron; aluminum; nickel; copper alloys and other nonferrous metals.

# SECTION 2: SAFETY AND HEALTH

---

Safe practices in welding and cutting processes, such as air carbon-arc, is covered in ANSI Z49.1, “Safety in Welding and Cutting”, and ANSI 249.2, “Fire Prevention in Use of Welding and Cutting Processes.” Air carbon-arc operators and their supervisors should adhere to the safe practices discussed in these documents.

Other hazards in arc welding and cutting are briefly discussed in this section.

### Proper Installation, Use, and Maintenance

Serious injury or death may result if gouging and cutting equipment is not properly installed, used, and maintained. Misuse of this equipment and other unsafe practices can be hazardous. The operator, supervisor, and helper must read and understand the following safety warnings and instructions before installing or using any air carbon-arc torch or equipment.

The gouging/cutting process is used in many potentially dangerous environments such as elevated heights, areas of limited ventilation, close quarters, around water, in hostile environments, etc., and it is important that the operators are aware of the dangers associated in working in these types of conditions. The operator(s) must be trained in safe practices for their work environments and under competent supervision.

It is essential that the operator, supervisor, and others in the work area are aware of the dangers of the air carbon-arc process. Training and proper supervision are important for a safe work place. Keep these instructions for future use. Additional recommended safety and operating information is referenced in each section.

### ELECTRIC SHOCK CAN CAUSE INJURY OR DEATH



Install and maintain equipment in accordance with the National Electrical Code (NFPA 70) and local codes. Do not service or repair equipment with power on. Do not operate equipment with protective insulators or covers removed. Service or repair to equipment must be done by qualified and/or trained personnel only.



## Electrodes

Keep carbon electrodes dry. If electrodes become damp, bake them for 10 hours at 300° F (176° C). **Wet electrodes may shatter.**

Do not contact electrically live parts. Do not touch electrode with bare skin and electrical ground at the same time. Always wear dry welding gloves in good condition. Aluminized protective clothing can become part of the electrical path. Keep oxygen cylinders, chains, wire ropes, cranes, hoists, and elevators away from any part of the electrical circuit. All ground connections must be checked periodically to determine that they are mechanically strong and electrically adequate for the required current.

When engaged in alternating current gouging/cutting under wet conditions or warm surroundings where perspiration is a factor, the use of reliable automatic controls for reducing no load voltage is recommended to reduce shock hazard. When the gouging/cutting process requires values of open circuit voltages in alternating current machines higher than 80 volts, and direct current machines higher than 100 volts, means must be provided to prevent the operator from making accidental contact with the high voltage by adequate insulation or other means.

When gouging is to be suspended for any substantial period of time, such as during lunch or overnight, all electrodes should be removed from the torch and the torch carefully located so that accidental contact cannot occur. The torch must be disconnected from the power source when not in use. Never immerse air carbon-arc torches or electrodes in water.

## SMOKE, FUMES, AND GASES CAN BE DANGEROUS TO YOUR HEALTH



### Ventilation Hazards

Keep smoke, fumes and gases from the breathing area. Fumes from the gouging process are of various types and strengths, depending on the kind of base metal being worked on. To ensure your safety, do not breathe these fumes. Ventilation must be adequate to remove smoke, fumes and gases during the operation to protect gouging operators and others in the area.

## AIR CARBON-ARC GUIDE

---

Vapors of chlorinated solvents can form the toxic gas “Phosgene” when exposed to ultraviolet radiation from an electric arc. All solvents, degreasers and potential sources of these vapors must be removed from the operating area.

Fumes produced by cutting particularly in confined places can cause discomfort and physical harm if inhaled over an extended period of time. Provide adequate ventilation in the gouging/cutting area. Use air-supplied respirators if ventilation is not adequate to remove all fumes and gases. Never ventilate with oxygen, because oxygen supports and vigorously accelerates fire.

### NOISE CAN DAMAGE HEARING



#### Personal Protective Equipment and Clothing

Noise from the air carbon-arc process can damage your hearing. Wear protective hearing devices to ensure protection when noise levels exceed OSHA standards. Adequate hearing protection devices must be worn by operators and surrounding personnel to ensure personal protection against noise.

#### Permissible Noise Exposure

Duration Per Day (hours)	Sound Level (dBA*) Slow Response
8	90
6	92
4	95
3	97
2	100
1-1/2	102
1	105
1/4 or less	115

\* dBA = decibels

**ARC RAYS, HOT SLAG, AND SPARKS CAN INJURE EYES AND BURN SKIN**

The gouging/cutting processes produce extreme localized heat and strong ultraviolet rays. Never attempt to gouge/cut without a welding helmet with the proper lens, that complies with federal guidelines. A number 12 to 14 shade filter lens provides the best protection against arc radiation. When in a confined area, prevent the reflected arc rays from entering around the helmet. Make sure others are protected from arc rays and sparks. Approved shielding curtains and appropriate goggles should be used to provide protection to others in the surrounding area and operators of nearby equipment.

Skin should also be protected from arc rays, heat and molten metal. Always wear protective gloves and clothing which will not allow skin to become exposed. All pockets should be closed and cuffs sewn shut. Leather aprons, sleeves, leggings, etc. should be worn for out-of-position gouging/cutting or for heavy metal-removal operations using large electrodes. High top work shoes provide adequate protection from foot burns. For added protection use leather spats. Flammable hair preparations should not be used when gouging/cutting. Wear ear plugs to protect ears from sparks.

**Shielding Booths**

Where the work permits, the arc welder should be enclosed in an individual booth painted with a finish of low reflectivity such as zinc oxide, an important factor for absorbing ultraviolet radiations, and lamp black, or shall be enclosed with noncombustible screens similarly painted.

**WELDING SPARKS CAN CAUSE FIRES AND EXPLOSIONS****Fire and Burn Hazards**

Causes of fire and explosion: combustibles reached by the arc, flame, flying sparks, hot slag or heated materials. Remove combustibles from the work area and/or provide a fire watch. Avoid oily or greasy clothing as a spark may ignite them. Have a fire extinguisher nearby, and know how to use it.

## AIR CARBON-ARC GUIDE

Be alert to the danger of conduction or radiation, for example if gouging/cutting is to be done on a metal wall, partition, ceiling or roof, precautions must be taken to prevent ignition of combustibles on the other side. Do not gouge/cut containers that have held combustibles. All hollow spaces, cavities and containers should be vented prior to gouging/cutting to permit the escape of air or gases. Purging with inert gas is recommended.

**Never use oxygen in an air carbon-arc torch.**

**Table 1 - Recommended Minimum Air Requirements**

Type of Torch	Air Pressure <sup>1</sup> psi (kPa)	Air Consumption cfm (L/min.)	Recommended Compressor Rating		
			Intermittent Use hp (kW)	Continuous Use hp (kW)	ASME Receiver Size gal (lit)
Light Duty <sup>2</sup>	40 (280)	8 (227)	0.5 (0.4)	1.5 (1.1)	60 (227)
General Duty <sup>2</sup>	80 (550)	25 (708)	5 (3.7)	7.5 (5.6)	80 (303)
Multipurpose <sup>3</sup>		33 (934)	7.5 (5.6)	10 (7.5)	
Automatic <sup>4</sup>	60 (414)	46 (1303)	N/A	15 (11.2)	

<sup>1</sup> Pressure while torch is in operation.

<sup>2</sup> Accommodates flat electrodes.

<sup>3</sup> Generally considered a foundry touch.

<sup>4</sup> Requires some kind of mechanical manipulation.

Use only compressed air. Use of combustible compressed gases can cause explosions resulting in personal injury or death.

**SAFETY AND OPERATING REFERENCES**

1. Code of Federal Regulations. (OSHA) Section 29 Part 1910.95, 132, 133, 134, 139, 251, 252, 253, 254 AND, 1000. U.S. Government Printing Office, Washington, DC 20402
2. ANSI Z49.1 "Safety In Welding and Cutting"
3. ANSI Z87.1 "Practice for Occupational and Educational Eye and Face Protection."
4. ANSI Z88.2 "Standard Practice for Respiratory Protection." American National Standards Institute, 1430 Broadway, New York, NY 10018.
5. AWS C5.3 "Recommended Practices for Air Carbon-Arc Gouging and Cutting."
6. AWS F4.1 "Recommended Safe Practices for Welding and Cutting Containers." The American Welding Society, 550 NW Lejeune RD., P.O.Box 351040, Miami FL. 33135
7. NFPA 51B "Fire Prevention in Cutting and Welding Processes" National Fire Protection Association, Battery Park. Quincy MA 02269
8. CSA Standard W117.2, "Safety in Welding. Cutting and Allied Processes" Canadian Standards Association, 178 Rexdale Blvd., Rexdale, Ontario, Canada M9W 1R3

## SECTION 3: PRINCIPLES OF OPERATION

### GENERAL

Like arc welding, CAC-A uses an intense arc to create a molten pool on the workpiece. Compressed air blows away this molten metal.

The process requires a welding power source, air compressor, carbon electrode, and gouging torch. Figure 1 illustrates the component arrangement.

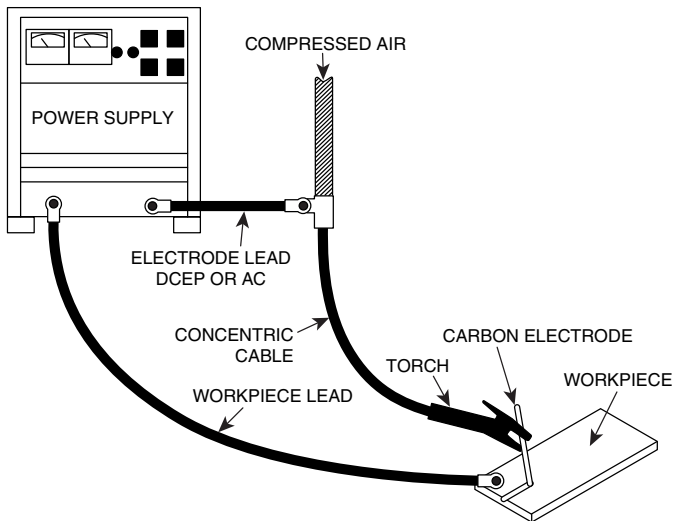

Figure 1: Air Carbon-Arc Setup

Cut or gouge only in the direction of air flow. The electrode angle varies, depending on the application. The operator should maintain the correct arc length so air will remove molten metal. See Figure 2.

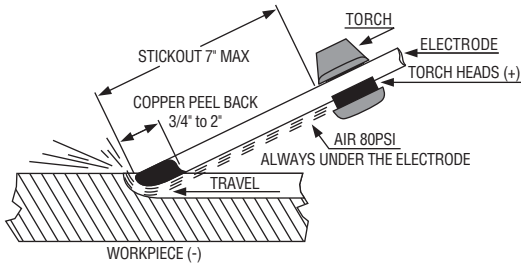

Figure 2: Principles of Air Carbon-Arc

## POWER SOURCES

Single-phase machines with low, open-circuit voltage may not work for air carbon-arc gouging (CAC-A). However, any three-phase welding power source of sufficient capacity may be used for air carbon-arc gouging. The open-circuit voltage should be higher than the required arc voltage to allow for a voltage drop in the circuit. The arc voltage used in air carbon-arc gouging and cutting ranges from a low of 35V (volts) to a high of 56V; thus, the open-circuit voltage should be at least 60V. The actual arc voltage in air carbon-arc gouging and cutting is governed by arc length and the type of gouging.

Aside from special uses addressed later, CAC-A is used with DCEP (reverse polarity). The electrode should extend at most 7" (178 mm) from the gouging torch, with the air jet between the electrode and workpiece. Use a minimum extension of 2" (50.8 mm). Torch parts will damage if the stickout of the electrode is less than the 2" (50.8 mm).

## COMPRESSED AIR

Use ordinary compressed air for air carbon-arc gouging. Normal pressures range between 80 psi (551.6 kPa) and 100 psi (690 kPa) at the torch; higher pressures may be used, but they do not remove metal more efficiently. Use 60 psi (413.7 kPa) with the light-duty manual torch. Do not use pressures this low with general duty torches.

## AIR CARBON-ARC GUIDE

---

Regardless of the pressure used with manual torches, the air hose, supplying air to the cable assembly connected to the torch body, should have an inside diameter (ID) of at least 3/8" (6.4 mm).

Mechanized torches with automatic arc-length control should have an air-supply hose with a minimum ID of 1/2" (12 mm).

Table 1 gives the consumption rates of compressed air for the manual and mechanized torches, plus the compressor power rating for intermittent and continuous use. Be sure the compressor's receiver tank is large enough for the compressor rating.

### ELECTRODES

The three types of electrodes are listed below.

1. **DC copper-coated electrodes** are most widely used because of their comparatively long electrode life, stable arc characteristics, and groove uniformity. These electrodes are made from mixing carbon and graphite with a binder. Baking this mixture produces dense, homogeneous graphite electrodes of low electrical resistance, which are then coated with a controlled thickness of copper. Available diameters:

- 1/8" (3.2 mm)
- 1/4" (6.4 mm)
- 1/2" (12.7 mm)
- 5/32" (4.0 mm)
- 5/16" (7.9 mm)
- 3/8" (4.8 mm)
- 3/8" (9.5 mm)

Jointed electrodes work without stub loss and are furnished with a female socket and a matching male tang. Available diameters:

- 5/16" (7.9 mm)
- 5/8" (15.9 mm)
- 3/8" (9.5 mm)
- 3/4" (19.1 mm)
- 1/2" (12.7 mm)
- 1" (25.4 mm)

Flat (rectangular) coated electrodes make rectangular grooves and remove weld reinforcements. Available diameters:

- 5/32" (4.0 mm) x 3/8" (9.5 mm)
- 3/16" (4.8 mm) x 5/8" (1-5.9 mm)

Half Round coated electrodes provides versatility of having both a round and flat electrode. Available diameters:

- 3/8" (9.5mm) x 5/32" (4.0mm)



- 2. DC plain electrodes** are used in diameters of less than 3/8" (9,5 mm). During gouging, they consume more rapidly than coated electrodes. They are made like the coated electrodes, but without the copper coating. Available diameters:
- 5/32" (4.0 mm)
  - 3/16" (4.8 mm)
  - 1/4" (6.4 mm)
  - 5/16" (7.9 mm)
  - 3/8" (9.5 mm)
- 3. AC coated electrodes** are made from carbon, graphite, and a special binder. Rare-earth materials are added to ensure arc stabilization when using alternating current. These electrodes are coated with copper. Available diameters:
- 3/16" (4.8 mm)
  - 1/4" (6.4 mm)
  - 3/8" (9.5 mm)

**Table: 2 Suggested Current Ranges (AMP) For  
Commonly Used Electrode Types and Sizes**

Electrode Diameter	DC Electrode DCEP	AC Electrode AC	AC Electrode DCEN
in (mm)	min - max	min - max	min - max
1/8 (3.2)	60 - 90	N/A	
5/32 (4.0)	90 - 150	N/A	
3/16 (4.8)	200 - 250	200 - 250	150 - 180
1/4 (6.4)	300 - 400	300 - 400	200 - 250
5/16 (7.9)	350 - 450	N/A	
3/8 (9.5)	450 - 600	350 - 450	300 - 400
1/2 (12.7)	800 - 1000	N/A	
5/8 (15.9)	1000 - 1250		
3/4 (19.1)	1250 - 1600		
1 (25.4)	1600 - 2200		
3/8 (9.5) FLAT	250 - 450		
5/8 (9.5) FLAT	300 - 500		



*The air carbon-arc process produces fumes of various types and strengths, depending on the kind of base metal. To ensure safety, do not breathe these fumes. Ventilate near the arc to protect air carbon-arc operators and others in the area. Sometimes, operators may need to use special breathing equipment. Be sure to test the air to ensure it is free of dangerous fumes.*

### WELDING CABLE LEADS

Table 3 gives the recommended number and sizes of welding leads for different currents and lengths.

### MANUAL GOUGING TORCHES

A manual torch is shown in Figure 3. The electrode is held in a swivel head containing one or more air holes, so that the air jet stays aligned with the electrode regardless of the electrode angle to the gouging torch.

Torches with two heads (the air jet is on two sides of the electrode), or with a fixed angle between the electrode and the holder, are better for some uses, e.g., removing pads and risers from large castings (padwashing).

Torches are usually air cooled. For high-current applications, water-cooled cable assemblies may be used with heavy-duty torches.

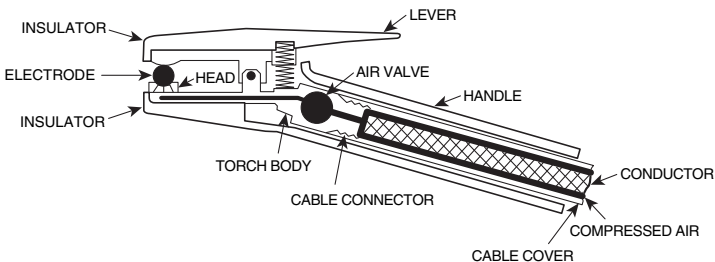

Figure 3: Manual Gouging Torch

**Table 3 - Recommended Number and Size of Welding Leads  
for Various Currents<sup>1,2</sup> and Lengths<sup>3,4</sup>**

Amps	25 ft (7 m)		50 ft (15 m)		100 ft (30 m)		150 ft (46 m)		200 ft (61 m)		250 ft (76 m)	
	No.	Size	No.	Size	No.	Size	No.	Size	No.	Size	No.	Size
100	1	4	1	3	1	2	1	1/0	1	2/0	1	4/0
200	1	3	1	2	1	1/0	1	3/0	1	3/0	3	3/0
300	1	2	1	2	1	3/0	2	2/0	2	4/0	4	4/0
400	1	2	1	1/0	1	4/0	2	4/0	3	4/0	5	4/0
500	1	1	1	2/0	2	2/0	2	4/0	4	4/0		
600	1	1	1	3/0	2	3/0	2	4/0	5	4/0		
800	1	1/0	2	2/0	2	4/0	4	4/0				
1000	1	2/0	1	4/0	3	3/0	5	4/0				
1200	1	3/0	2	4/0	3	4/0						
1400	1	4/0	2	4/0	4	3/0						
1600 <sup>5</sup>	2	3/0	4	3/0	4	4/0						
1800	2	4/0	4	4/0								
2000 <sup>6</sup>	3	4/0	5	4/0								

<sup>1</sup> Recommendations are based on 4V, DC drop per 100 ft.

<sup>2</sup> For AC, use next heavier size.

<sup>3</sup> The length given is one half the sum of the electrode and ground leads.

<sup>4</sup> Inadequate grounding causes cable overheating; at least 1 in.<sup>2</sup> (645mm<sup>2</sup>) of contact per 1000 amps.

<sup>5</sup> Over 1600 amps, use a heavy-duty, air-cooled concentric cable.

<sup>6</sup> Over 2000 amps, use a heavy-duty, water-cooled concentric cable.

# SECTION 4: OPERATING TECHNIQUES

---

### CONTROLLING AUTOMATIC GOUGING TORCHES

There are two methods of controlling automatic air carbon-arc gouging torches. Either method can make grooves of consistent depth to a tolerance of  $\pm 0.025$ " ( $\pm 0.64$  mm). These automatic units are used to achieve high quality gouges and increase production. (See Figure 4)

#### The methods are as follows:

1. The voltage-controlled method maintains arc length by voltage signals through solid-state electronic controls. This method controls the electrode feed speed, which maintains the preset voltage. It can run with constant current (CC) power supplies.

---

#### NOTE

---

*The N6000 Automatic Gouging System developed by Arcair® can run on either "CC" or "CP".*

2. The amperage-controlled method maintains the arc current by amperage signals through solid-state controls. This method controls the electrode feed speed, which maintains the preset amperage. It is run with constant-voltage (CP) power sources only.

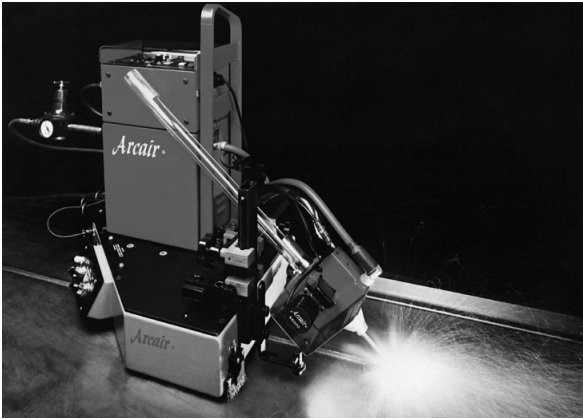

Figure 4: Controlling Automatic Gouging Torches

### **GOUGING WITH MANUAL TORCHES**

The electrode should be gripped, as shown in Figure 2, so a maximum of 7" (178 mm) extends from the torch.

For aluminum, this extension should be 3" (76.5 mm). Table 2 shows suggested currents for the different electrode types and sizes.

Turn on the air jet before striking the arc, and hold the torch as shown in Figure 5. The electrode slopes back from the direction of travel with the air jet behind the electrode.

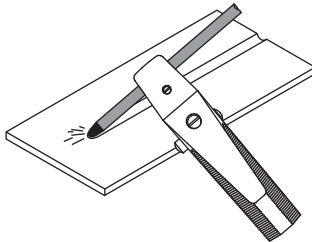

Figure 5: Flat Gouging Position

## AIR CARBON-ARC GUIDE

---

During gouging, the air jet sweeps beneath the electrode end and removes all molten metal. The arc can be ignited by lightly touching the electrode to the workpiece. The electrode should not be drawn back once the arc is ignited.

Gouging is different from arc welding because metal is removed, not deposited. To maintain a short arc, work in the direction of the cut fast enough to keep up with metal removal. Steadiness of movement controls the smoothness of the resulting cut.

For gouging vertically, hold the gouging torch as shown in Figure 6. Perform gouging downhill to permit gravity to help remove the molten metal.

Vertical gouging may be done uphill, but it is difficult. Gouging horizontally may be done either to the right or left, but always with forehand gouging.

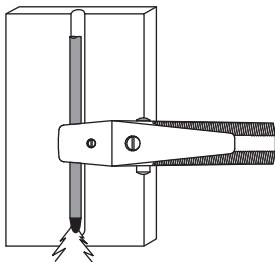

Figure 6: Vertical Gouging Position

In gouging to the left, hold the torch as shown in Figure 7. In gouging to the right, reverse the torch hold. Position the air jet behind the electrode. When gouging in the overhead position, as shown in Figure 8, hold the electrode and torch so molten metal will not drip on the operator's glove.

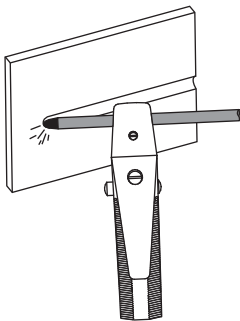

Figure 7: Horizontal Gouging Position

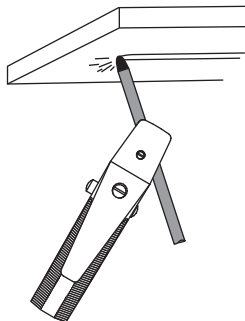

Figure 8: Overhead Position

The groove's depth is controlled by travel speed. Grooves up to 1" (25 mm) deep may be made. However, the deeper the groove, the more experienced the operator needs to be. Slow travel speed produces a deep groove, with fast travel speeds producing a shallow groove. The width of the groove is determined by the size of the electrode used and is typically about 1/8" (3.2 mm) wider than the electrode's diameter. A wider groove may be made with a small electrode by oscillating in a circular or weave motion.

When gouging, use a push angle of 35° from the workpiece surface for most applications. A steady rest ensures a smoothly gouged surface, especially in the overhead position.

Proper travel speed depends on the size of the electrode, the base metal used, amperage, and air pressure. Proper speed (produces a smooth hissing sound) results in a good gouge.

## **SEVERING**

Figure 9 shows the electrode ready for severing. The severing technique is like gouging, except the operator holds the electrode at a steeper angle, between 70° and 80° to the workpiece surface.

For cutting thick nonferrous metals, hold the electrode perpendicular to the workpiece, with the air jet favoring the desired side. Then, the operator severs the metal by moving the arc up and down with a sawing motion.

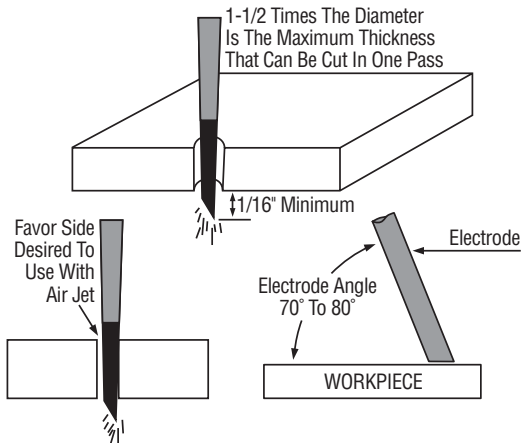

Figure 9: Electrode Severing

Gouging torches with fixed-angle heads are well suited for this application because they hold the electrode at the correct angle. With other types of torches, be sure to keep the air behind the electrode. The steadiness of the operator determines the smoothness of the surface produced.

### WASHING

Position the electrode as shown in Figure 10 to use the air carbon-arc process for removing metal from large areas, surfacing metal, and riser pads on castings. Weave the electrode from side-to-side while pushing forward at the depth desired. In the pad-washing operation, use an angle of 15° to 70° to the workpiece. Use the 15° angle for light finishing passes. Steeper angles perform deeper rough gouging with more ease. To padwash:

1. Keep the torch parallel to the workpiece and weave side-to-side across the width of the area to be cleaned.
2. Maintain forward motion across the workpiece.



3. Hold the electrode work angle  $15^{\circ}$  to  $70^{\circ}$  (mainly on cast iron). The shallower angles produce a smoother finish.

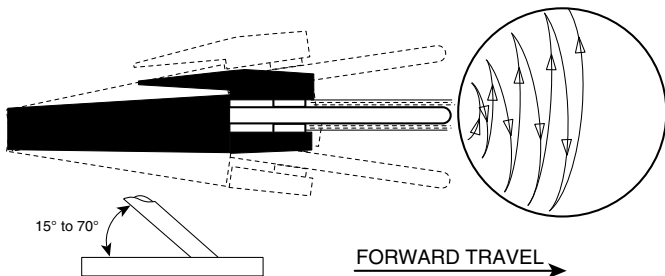

Figure 10: Pad-Washing Technique

## BEVELING

To use beveling method for thick plates, hold the electrode as in Figure 11A, with a travel angle of  $90^{\circ}$  and a work angle equal to the bevel angle. Place the air jet between the electrode and the workpiece.

The beveling method used for thin plates is shown in Figure 11B. Hold the torch parallel to the edge being beveled, with the electrode angle equal to the bevel angle. Place the air jet between the electrode and the workpiece surface.

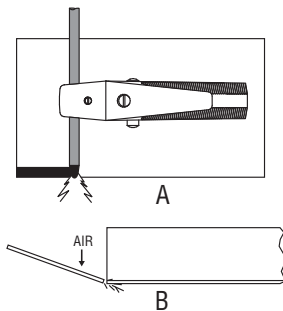

Figure 11: Beveling

# AIR CARBON-ARC GUIDE

## Table 4 - Automatic CAC-A U-Groove Operating Data

Electrode in (mm)	Desired Depth in (mm)	Speed in (mm)	AMP
5/16 (7.94)	1/8 (3.2)	65 (1651)	400
	3/16 (4.8)	45 (1143)	
	1/4 (6.4)	36 (914)	
	5/16 (7.9)	33 (838)	
	7/16 (11.1)	22.5 (572)	
3/8 (9.53)	1/8 (3.2)	70 (1778)	500
	3/16 (4.8)	44 (1118)	
	1/4 (6.4)	35 (889)	
	3/8 (9.5)	20 (508)	
	9/16 (14.3)	17.5 (445)	
1/2 (12.7)	1/8 (3.2)	96 (2438)	850
	1/4 (6.4)	57 (1448)	
	3/8 (9.5)	35 (889)	
	1/2 (12.7)	24 (610)	
	3/4 (19.1)	17.5 (445)	
5/8 (15.88)	1/4 (6.4)	72 (1829)	1250
	3/8 (9.5)	48 (1219)	
	1/2 (12.7)	37 (940)	
	5/8 (15.9)	30 (762)	
	15/16 (23.8)	19.5 (495)	
3/4 (19.05)	1/4 (6.4)	72 (1829)	1400
	3/8 (9.5)	42 (1068)	
	1/2 (12.7)	34 (865)	
	5/8 (15.9)	27 (687)	
	3/4 (19.1)	22 (560)	
	1 1/8 (28.6)	14 (330)	

Tabulations are based on the laboratory conditions. Use this information as a guide and adjust for field variance.

For a groove depth greater than 1 1/2 times the diameter of the electrode being used, make the groove in two or more passes.

**Table 5 - Automatic CAC-A J-Groove Operating Data**

Material Size in (mm)	Electrode Size <sup>1</sup> in (mm)	AMP <sup>2</sup>	Electrode Overhang in (mm)			Travel Speed* in (mm)			Overall Speed
			1 Pass	2 Pass	3 Pass	1 Pass	2 Pass	3 Pass	
3/8 (9.53)	5/16 (7.94)	450	0.063 (1.6)	N/A	N/A	65 (1651)	N/A	N/A	65 (1651)
1/2 (12.7)						35 (889)			35 (889)
5/8 (15.88)	3/8 (9.53)	600	0.063 (1.6)	N/A	N/A	50 (1270)		N/A	25 (635)
3/4 (19.05)						37 (940)			18.5 (470)
1 (25.4)	5/8 (15.88)	1250	0.125 (3.2)		N/A	40 (1016)		N/A	20 (508)
1.5 (38.1)			0.063 (1.6)			47 (1194)			16 (406)
2.0 (50.8)			0.125 (3.2)			28 (711)			9.5 (241)

Table Air Properties: 47 cfm (1331 L/min) and 60 psi (414 kPa)

<sup>1</sup> Electrode Angle at 45° with 3.0" (76.2 mm) stick out.

<sup>2</sup> Powered at 42V.

\* Per Minute.

# SECTION 5: EQUIPMENT SELECTION

---

## GOUGING TORCH GUIDE

Torches range from light-duty farm and body shop sizes to extra heavy-duty foundry torches, each applicable to specific types of jobs.

### 1. **Angle-Arc® Torches**

#### a. **K2000™**

- Light-duty general purpose torch
- Accepts 1/8" (3.2 mm) to 1/4" (6.4 mm) round electrodes and 3/8" (9.5 mm) flat electrodes
- Maximum of 450 amperes

#### b. **K3000™**

- Medium-duty general purpose torch
- Accepts 5/32" (4.0 mm) to 3/8" (9.5 mm) round electrodes and 3/8" (9.5 mm) flat electrodes
- Maximum of 600 amperes

#### c. **K4000®**

- Heavy-duty general purpose torch
- Accepts 5/32" (4.0 mm) to 1/2" (12.7 mm) round electrodes and 3/8" (9.5 mm) and 5/8" (15.9 mm) flat electrodes
- Maximum of 1000 amperes

### 2. **Tri-Arc®, Foundry / Heavy Duty**

General foundry work and heavy-duty fabrication. Limited to 1600 amps with air-cooled cables and 2000 amps with water-cooled cables.

### 3. **Automatic Arcair-Matic® N6000**

Edge preparations and backgouging; high quality, high productivity electrode uses. Used with 5/16" - 3/4" (7.9 mm - 19.1 mm) jointed carbons.

## **POWER SOURCES**

Use any three-phase welding power source with enough capacity for the air carbon-arc gouging process. However, be sure the open circuit voltage is high enough to allow for a voltage drop in the circuit. Some constant voltage with drooping characteristics require very high OCV to run air carbon-arc gouging equipment. Single-phase power sources are usually too small for this process.

Power sources in conjunction with mechanized gouging should be 100% duty cycle for the required amperage.

1. **DC, constant current (motor generator, rectifier, or resistor grid unit)**

Preferred power supply for all electrode sizes.

2. **DC, constant voltage (motor generator or rectifier)**

Usable only for 5/16" (7.9 mm) and larger diameter electrodes. May cause carbon deposits with smaller electrodes. Not suitable for automatic torches with voltage control only.

3. **AC, AC constant current (transformer)**

Recommended for AC electrodes only.

4. **AC/DC transformer rectifiers**

DC supplied from three-phase transformer rectifier sources is satisfactory, but DC from single-phase supplies gives unsatisfactory arc characteristics. AC output from AC/DC is satisfactory, provided AC electrodes are used.

## AUTOMATIC SYSTEMS

Automatic systems are often used in today's fabrication industry. These systems offer a high quality, high-productivity alternative to manual gouging. There are two types of systems to be considered, both operating on a signal from the arc to control gouging.

### 1. Dual-Signal System

With this type of automatic system, either constant current (CC) or constant voltage (CV) power supplies can be used. When on CC, the arc length is maintained through a voltage-signal system. The system controller has a predetermined voltage setting, which advances or retracts the electrode through a stepping motor to maintain the arc length. On a CV power supply, amperage sensing controls the electrode feed or retraction to maintain the right arc current.

### 2. Single Signal System

Like the dual-signal system, this system also maintains arc length through a voltage signal. It will not, however, operate with an amperage signal. This type of system operates only on a CC power supply.

### *Advantages*

Automatic CAC-A systems ensure better productivity and quality.

The systems can perform:

- out-of-position gouging
- long gouges in flat work pieces with a moving gouging apparatus
- circular gouges in pipes and tanks with a stationary gouging apparatus

In addition, they perform an even U-groove shape and can control depth of groove to within  $\pm 0.025"$  ( $\pm 0.64$  mm). Tables 4 and 5 show operating information for both U- and J-grooves.

---

## **SECTION 6: IMPORTANT PROCESS VARIABLES**

---

### **PROCESS VARIABLES**

Like any thermal-cutting process, air carbon-arc gouging is sensitive to variables in operation. Variables can cause changes in the finished gouge that range from undetectable to unacceptable results.

Here are some variables in air carbon-arc process:

<b>Electrode Diameter</b>	Determines the size of the groove.
<b>Amperage</b>	Determined by the diameter of electrode being used. This current flow melts the base metal.
<b>Voltage</b>	The pressure behind the amperage, or arc force. Determined by arc length on CC power supplies and set on CV power supplies.
<b>Air Pressure and Flow Rate</b>	The medium for removing molten metal.
<b>Travel Speed</b>	Determines the depth/quality of a finished groove.
<b>Electrode Travel and Work Angle</b>	Can determine groove shape.
<b>Electrode Extension</b>	Affects metal removal rates and quality of groove.
<b>Base Metal</b>	Affects many other variables.

### **ELECTRODE DIAMETER AND TYPE**

The electrode's size and type determine groove size. The electrode also affects productivity, groove quality, and metal-removal rates. The width of the groove will be about 1/8" (3.2 mm) wider than the diameter of the electrode.

Determine the proper electrode by desired groove size. Available power dictates the outer limit.

### **Example**

To achieve the following groove dimensions:

1/2" (12.7 mm) width      1/4" (6.4 mm) depth      10" (254 mm) length

Perform manual pass twice using a 1/4" (6.4 mm) electrode or one pass with a 3/8" diameter electrode. In the first case, the best gouging rate would be 10" per minute (ipm) divided by 2 or 5 ipm. The latter travel speed is 17 ipm.

Here, the 3/8" (9.5 mm) diameter electrode gives a 200% increase in gouging rate that could offset the added electrode cost. Automatic systems further increase the productivity rate through finite control of the arc voltage.

### **AMPERAGE**

The gouging amperage is the melting force and is affected by electrode size. For example, if the amperage is set too low for the electrode size, the base metal's melting rate would be inadequate and cause free carbon deposits. Conversely, a setting too high would still melt the base metal but rapidly deteriorate the electrode while reducing the metal removed per electrode, and could also substantially reduce torch life.

### **VOLTAGE**

Voltage is the pressure or arc force that enables the current to flow across the arc gap. CAC-A often requires a higher voltage than do most welding processes. To ensure proper operation, use a power supply with high enough open-circuit voltage to maintain a 35-volt operating minimum. Not enough voltage can create a sputtering arc or it can prevent arc establishment, resulting in uneven grooves and probably free carbon deposits. These both require excessive grinding to remove.

### **AIR PRESSURE AND FLOW RATE**

The air jet removes molten metal. Adequate pressure and flow rate are required for proper results. Keep in mind that air volume (cfm or L/min) is as important as air pressure (psi or kPa). Pressure is the speed of air that moves the molten metal from the groove. If there is not enough air volume to lift molten material out of the groove, the pressure or velocity cannot remove it. The result is excessive slag adhesion and unnecessary grinding to clean up the groove.



## TRAVEL SPEED

Speed affects gouge depth and groove quality. The faster the travel of an electrode, the more shallow the gouge. Use a smaller electrode if the travel speed is too fast for the operator's comfort, or try automatic gouging. Making a groove too deep for the electrode's diameter results in a poor quality groove that requires much grinding.

## ELECTRODE PUSH ANGLE

The electrode's push angle can vary. When gouging manually, a steeper angle tends to give a more V-shaped groove. With the automatic system, a steeper angle produces a slightly deeper groove at the same travel speed.

## BASE METALS GOUGING RECOMMENDATIONS

Recommended Procedures:

1. **Carbon steel and low alloy steel** (e.g., ASTM A514 and A517) – Use DC electrodes with DCEP (electrode positive). AC electrodes with an C transformer can be used, but for this application, AC is only half as efficient as DC.
2. **Stainless steel** – Same as for carbon steel.
3. **Cast iron**, including malleable and ductile iron (nodular) – Use 1/2" (12.7 mm) or larger electrodes at the highest rated amperage.

---

### NOTE

---

*Use special techniques when gouging these metals listed above. The push angle should be at least 70° off the workpiece. The depth of the cut should not exceed 1/2" (12.7 mm) per pass.*

4. **Copper alloys** (copper content 60% and under) – Use DC electrodes with DCEN (electrode negative) at the electrode's highest amperage rating.
5. **Copper alloys** (copper content over 60% or large workpiece size) – Use DC electrodes with DCEN at maximum amperage rating of the electrode or use AC electrodes with AC.
6. **Aluminum Bronze and Aluminum Nickel Bronze** (special naval propeller alloy) – Use DC electrodes with DCEN.
7. **Nickel alloys** (nickel content is over 80% of mass) – Use AC electrodes with AC.
8. **Nickel alloys** (nickel content less than 80% of mass) – Use DC electrodes with DCEP.

## AIR CARBON-ARC GUIDE

---

9. **Magnesium alloys** – Use DC electrodes with DCEP. Wire brush groove before welding.
10. **Aluminum** – Use DC electrodes with DCEP. Wire brush with stainless wire brushes before welding. Electrode extension (length of electrode between torch and work) should not exceed 3" (76.2 mm). DC electrodes with DCEN can also be used.
11. **Titanium, Zirconium, Hafnium, and associated alloys** – Do not cut or gouge to prepare for welding or remelting unless the surface layer is mechanically removed from cut surface.

---

### NOTE

---

*If operator preheats for welding, then preheat for gouging.*

### EFFECTS OF THE CAC-A PROCESS ON BASE METALS

Metallurgical occurrences during air carbon-arc gouging and cutting processes:

With DCEP, and the corresponding half cycle of alternating current, the current flow carries ionized carbon atoms from the electrode to the base metal. The base metal quickly absorbs the free carbon particles. Since this absorption is inevitable, use the air jet to remove all carburized molten metal from the kerf.

When the air carbon-arc process is used under improper conditions, carburized molten metal may be left on the workpiece surface. Its color is usually a dull gray-black, in contrast to the bright blue of the properly made groove. Inadequate air flow may leave small pools of carburized metal in the bottom of the groove. Irregular electrode travel, especially in a manual operation, may cause ripples in the groove wall that trap the carburized metal. Finally, an improper electrode push angle may cause small beads of carburized metal to remain on the groove's edge.

The carburized metal can compromise the workpiece for future welding if it stays on the cut surface. These effects depend on the amount of carburized metal present, welding process used, type of base metal, and required weld quality. Despite misconceptions that filler metals put on the surface during welding would absorb small pools or beads of carburized metal, working with steel base metals shows that trace metal with only 1% carbon may stay along the weld interface. Such flaws may lessen weld strength and toughness.

Copper from copper-coated electrodes does not transfer to the cut surface in base metal, unless the process is improperly used.

Remove carburized metal from a cut surface by grinding, but prevent grinding by gouging properly in the right conditions.

Studies were conducted on stainless steel to determine whether air carbon-arc gouging, when carried out in the prescribed manner, adversely affects corrosion resistance. The studies showed no significant difference in the corrosion rates for welds prepared by CAC-A and those prepared by grinding (See Table 6). Had carbon been absorbed, the corrosion rates for welds backgouged by CAC-A would have been significantly higher. In the studies, type 304L stainless steel was welded using several processes. Backgouging of the joint was performed by air carbon-arc gouging and by grinding. Specimens from the joints were subjected to the boiling 65% nitric-acid test.

Compared to oxy-fuel gas cutting, CAC-A is a lower-heat-input process. Therefore, a workpiece gouged or cut by CAC-A is less distorted. The machining of low carbon and non-hardenable steels is not affected by the air carbon-arc process. With cast iron and high-carbon steels, however, this process may cause enough hardening to make the cut surface tough to machine. Still, because the hardened zone is shallow, approximately, 0.06" (0,15 mm), a cutting tool can penetrate the hardened zone to remove the hardened surface.

**Table 6 - Results of Corrosion Testing on Type 304L Stainless**

Specimen	Process	Position	Root Preparation	Corrosion Rate per month in (mm)
HC1	GMAW	Horizontal	CAC-A Gouging	0.000593 (0.01505)
HC2	GTAW			0.000594 (0.01509)
HG1	GMAW		Grinding	0.000646 (0.0164)
HG2	GTAW			0.000618 (0.0157)
VC1	GMAW	Vertical	CAC-A Gouging	0.000686 (0.01742)
VC2	SMAW			0.000627 (0.01593)
VG			Grinding	0.000667 (0.01695)
OG	Overhead	Grinding	0.000632 (0.01605)	
OC			CAC-A Gouging	0.000645 (0.01638)

# SECTION 7: ADVANTAGES

---

### **Fast**

Five times faster than chipping. Gouges a groove 3/8" (9.5 mm) deep at over 2 ft. (600 mm) per minute.

### **Easily controllable**

Precisely removes defects. Defects are clearly visible in the groove and may be followed with ease. The depth of the cut is easily controlled and slag does not hamper the cutting action.

### **Low cost**

Gas cylinders and regulators are unnecessary except in field operations.

### **Economical to operate**

No oxygen or fuel gas required. The welder or welding operator may also do the gouging or cutting.

### **Easy-to-operate**

Welders operate the equipment after only a few minutes and become skilled in a few days. The torch contains an air-control valve and swivel head that permit changing the electrode angle to suit the job while maintaining air-jet alignment.

### **Compact**

Not much larger than a shielded metal arc welding torch.

### **Versatile**

Use it anywhere welding occurs. May be operated in spaces too restricted for a chipping hammer or an oxy-fuel gas cutting torch. Needs no difficult adjustments for use on different metals.

### **Clean cutting**

Resulting surface is clean and smooth. Welding or brazing is often done without further grinding or cleaning of the groove.

---

## **SECTION 8: APPLICATIONS AND TROUBLESHOOTING**

---

### **AREAS OF APPLICATION**

<b>Agriculture</b>	Preparing for welding the joints of broken metals on farm machinery. Removing surface welds. Severing metals.
<b>Aircraft</b>	Maintaining ground equipment and airport structures. Re-working dies and fixtures.
<b>Automotive</b>	Maintaining equipment. Preparing broken cast-iron parts. Severing metals. Removing broken or seized bearing races, collars, etc. from shafts.
<b>Boiler Shops</b>	Removing rivets and defective welds. Preparing cracks for re-welding. Removing tubes from tube sheets.
<b>Breweries</b>	Maintaining equipment (e.g., vats, piping). Cutting and gouging all types of metals, especially stainless steels.
<b>Chemical Plants</b>	Preparing equipment and piping of stainless steel and nonferrous metals for repair and alteration by welding.
<b>Construction</b>	Preparing joints for welding. Removing defects in welds. Fabricating without beveling. Removing holding clips, lifting pads, etc. without damage to pads or structure. Maintaining equipment.
<b>Dredging</b>	Maintaining equipment. Preparing manganese steel parts for repair by welding. Removing surfacing for resurfacing.
<b>Foundries</b>	Padwashing. Removing fins and risers. Removing cracks, sand pockets, and other defects from casting. Maintaining equipment.
<b>Surfacing</b>	Removing old surface welds for re-surfacing. Preparing stainless and manganese steels for welding. Removing defective welds.
<b>Lumber Industry</b>	Maintaining equipment. Removing surface welds for resurfacing. Dismantling damaged equipment for repair and reuse. Preparing cast iron for welding or brazing welding.

## **AIR CARBON-ARC GUIDE**

---

<b>Maintenance Shops</b>	Dismantling and remodeling equipment. Removing surfacing welds for resurfacing. Severing metals. Preparing damaged areas for repair welding.
<b>Army/Marines</b>	Removing austenitic weld metal. Backgouging welds for welding the second side. Salvaging armor plates. Severing metals. Removing defects in welds and castings.
<b>Navy/Coast Guard</b>	Removing defects in welds and castings. Backgouging to weld the second side. Removing austenitic weld metals. Removing padeyes, dogs, etc. without damage to attachments or to existing structures. Grooving of thin plate for welding. Removing eroded areas on ships' hulls, stern tubes, struts, rudders, and propellers for repair by welding. Removing of bulkheads, patches, and access hatches for reuse by damage control.
<b>Mining</b>	Maintaining equipment. Gouging manganese steels, cast iron, and all nonferrous metals. Removing surface welds and hardfacing.
<b>Oil Refineries</b>	Removing defective welds. Cutting and gouging stainless and austenitic welds. Cutting out or patching tank bottoms and coke-and-pipe stills. Removing liners, boiler and heat-exchanger tubes, and rivets. Removing defects and preparing breaks in castings for repair by welding. Severing nonferrous metals. Removing risers on castings. Preparing the surface of eroded and corroded areas on acid-plant equipment for rebuilding by welding.
<b>Oil Drilling</b>	Grooving for welding of plates. Removing drill collars. Removing surface welds for re-surfacing. Gouging out defects and grooving edges of castings (mud pumps), etc. for welding. Maintaining equipment. Removing fish plates on truck chassis for renewal. Grooving of broken edges for re-welding.
<b>Packing Houses</b>	Preparing equipment, vats and piping of stainless steel and nonferrous metal for welding.

<b>Power Plants</b>	Maintaining equipment. Grooving of metal for welding. Gouging out castings for repair. Removing cavities from Pelton wheels. Removing welded end tubes from tube sheets. Removing welding defects. Gouging and preparing cast iron for welding or braze welding.
<b>Salvage Yards</b>	Cutting scrap. Removing welds without injuring reusable structures. Cutting stainless steel, nonferrous metals, and cast iron.
<b>Railroads</b>	Maintaining equipment. Removing journal liners, rivets, welded end tubes from tube sheets. Preparing breaks in boilers, fire boxes, etc., for repair by welding. Salvaging and rescuing after equipment wreckage. Preparing for weld surfacing or its removal from frogs, switches, and rail ends. Preparing manganese steel for welding. Removing riser pads and defects from castings in foundries. Preparing worn wheels for rebuilding by welding.
<b>Shipbuilding</b>	See Navy/Coast Guard.
<b>Stainless Shops</b>	Cutting stainless steel. Removing defects in stainless steel castings and welds.
<b>Steel Fabrication</b>	Welding and fitting plates without beveling by backgouging the second side to sound metal after welding the first side. Removing welds from existing structures and salvaging undamaged material for reuse. Cutting and gouging all metals in the shop and at the job site. Maintaining equipment.
<b>Steel Mills</b>	Maintaining equipment. Cutting and gouging all metals. Washing billets and blooms. Removing defects.
<b>Waterworks</b>	Preparing broken equipment for repair by welding. Cutting and gouging all metals. Cutting cast-iron pipe, especially concrete lined. Removing welds so defective pipe sections can be replaced.
<b>Welding Shops</b>	Removing welds. Cutting all metals, especially nonferrous metals, stainless steel, and cast iron. Gouging bevels and backgouging weld roots. Removing surface weld for re-surfacing.

## TROUBLESHOOTING

Problem	Cause	Solution
Large free-carbon deposit at the beginning of the groove.	<ol style="list-style-type: none"><li data-bbox="323 189 664 342">1. The operator either neglected to turn on the air jet before striking the arc or the torch was located improperly.</li><li data-bbox="323 391 664 451">2. Carbon rod not positioned properly in head assembly.</li></ol>	<ol style="list-style-type: none"><li data-bbox="678 189 961 338">1. Turn on air before striking the arc and air should flow between the electrode and the workpiece.</li><li data-bbox="678 391 961 476">2. Ensure carbon rod is seated in groove in torch head.</li></ol>
An unsteady arc, causing the operator to use a slow travel speed even on shallow grooves.	<ol style="list-style-type: none"><li data-bbox="323 486 664 758">1. Not enough amperage for the electrode diameter used (see Table 2, Page 3-12). While the lowest recommended amperage may be enough, it requires greater operator skill. A mid-range amperage is better.</li></ol>	<ol style="list-style-type: none"><li data-bbox="678 486 961 758">1. If the desired amperage cannot be obtained from the available power source, use the next smaller diameter electrode or parallel two or more welding power supplies.</li></ol>
Erratic groove with the arc wandering from side-to-side and with the electrode heating up rapidly.	<ol style="list-style-type: none"><li data-bbox="323 768 664 828">1. The process used with DCEN (electrode negative).</li></ol>	<ol style="list-style-type: none"><li data-bbox="678 768 961 1157">1. Gouging process should be done with DCEP (Electrode positive) whenever possible. Direct current electrodes should be used with DCEP (electrode positive) on all metals, except for a few copper alloys such as Superston and Nialite. Refer to page 4-20.</li></ol>



Problem	Cause	Solution
<p>Intermittent arc action resulting in an irregular groove surface.</p>	<ol style="list-style-type: none"> <li>1. The travel speed was too slow in manual gouging. The operator possibly set their hand on other work for balance, a tendency in shielded metal-arc welding. Since the speed of air carbon-arc gouging is much faster than shielded metal-arc welding, friction between the gloved hand and the workpiece may cause a jerky forward motion thus causing the gap between the electrode and workpiece to become too large to maintain the arc.</li> <li>2. Poor ground connection.</li> </ol>	<ol style="list-style-type: none"> <li>1. The operator should stand comfortably so their arms move freely and their gloves do not drag on the workpiece. If using mechanized equipment, check Table 4 (Page 4-24) for proper operating conditions.</li> <li>2. Inspect ground clamps and lead(s) to ensure connection proper.</li> </ol>
<p>In gouging, free carbon deposits at varying groove intervals; in pad-washing, free carbon deposits at various spots on the washed surface.</p>	<ol style="list-style-type: none"> <li>1. A shorted electrode on the workpiece. In manual gouging, this is a result of excessive travel speed for the amperage used and for the depth of the groove being made. In mechanized operations, this is a result of excessive travel speed or using a flat-curve, constant-voltage power source for a small diameter electrode 5/16" (7,9 mm). In padwashing, this is caused by holding the electrode at too small a push angle.</li> </ol>	<ol style="list-style-type: none"> <li>1. Use an electrode-to-work angle of 15° to 70°. A smaller angle increases the arcing area, reducing the current density; this reduction in arc-current density requires a great decrease in arc length, to the point of short circuiting. Keep a proper arc gap.</li> </ol>
<p>Irregular groove: too deep, then too shallow.</p>	<ol style="list-style-type: none"> <li>1. The operator was unsteady.</li> </ol>	<ol style="list-style-type: none"> <li>1. The operator should assume a comfortable position while gouging.</li> </ol>

## AIR CARBON-ARC GUIDE

Problem	Cause	Solution
Slag adhering to the edges of the groove.	1. Slag ejection was inadequate. To resolve, keep a proper air pressure and flow rate (cfm). Air pressure between 80 and 100 psi (550-690 kPa) may not effectively eject all of the slag if the volume is insufficient.	1. To deliver adequate volume, the air hose feeding the concentric cable assembly needs a minimum hose ID of 3/8" (9.5 mm) for manual torches. For automatic torches, the minimum hose ID should be 1/2" (12.7 mm). Direct the air jet parallel to the gouge area. Do not favor one side unless operator wants to minimize slag from adhering to one side of the cut.



## **U.S. Customer Care:**

**ARCAIR® / STOODY® / THERMAL ARC® / THERMAL DYNAMICS® /**

**TWECO® / VICTOR® ..... 800-426-1888 / FAX 800-535-0557**

**FIREPOWER® ..... 800-858-4232 / FAX 800-535-0557**

**TURBOTORCH® ..... 800-238-0282 / FAX 800-535-0557**

**TDC AUTOMATION ..... 866-279-2628 / FAX 800-535-0557**

**VICTOR MEDICAL ..... 800-382-8187 / FAX 800-535-0557**

**VICTOR SPECIALTY PRODUCTS ..... 800-569-0547 / FAX 800-535-0557**

**Canada Customer Care: 905-827-4515 / FAX 800-588-1714**

**International Customer Care: 940-381-1212 / FAX 940-483-8178**

**CIGWELD Customer Care: 1300-654-674 / FAX 61-3-9474-7391**

**[www.thermadyne.com](http://www.thermadyne.com)**



**THERMADYNE® A Global Cutting & Welding Market Leader™**

### **WORLD HEADQUARTERS:**

16052 Swingley Ridge Road, Suite 300 • St. Louis, Missouri 63017 U.S.A.

#### **THE AMERICAS**

##### **Denton, TX USA**

##### **U.S. Customer Care**

Ph: 1-800-426-1888 (tollfree)

Fax: 1-800-535-0557 (tollfree)

##### **Miami, FL USA**

##### **Sales Office, Latin America**

Ph: 1-954-727-8371

Fax: 1-954-727-8376

##### **Oakville, Ontario, Canada**

##### **Canada Customer Care**

Ph: 1-905-827-4515

Fax: 1-800-588-1714 (tollfree)

##### **International Customer Care**

Ph: 1-940-381-1212

Fax: 1-940-483-8178

#### **EUROPE**

##### **Chorley, United Kingdom**

##### **Customer Care**

Ph: +44 1257-261755

Fax: +44 1257-224800

##### **Milan, Italy**

##### **Customer Care**

Ph: +39 0236546801

Fax: +39 0236546840

#### **ASIA / PACIFIC**

##### **Cikarang, Indonesia**

##### **Customer Care**

Ph: 6221-8990-6095

Fax: 6221-8990-6096

##### **Rawang, Malaysia**

##### **Customer Care**

Ph: +603 6092-2988

Fax: +603 6092-1085

##### **Melbourne, Australia**

##### **Australia Customer Care**

Ph: 1300-654-674 (tollfree)

Ph: 61-3-9474-7400

Fax: 61-3-9474-7391

##### **Shanghai, China**

##### **Sales Office**

Ph: +86 21-64072626

Fax: +86 21-64483032

##### **Singapore**

##### **Sales Office**

Ph: +65 6832-8066

Fax: +65 6763-5812

##### **International**

Ph: 61-3-9474-7508

Fax: 61-3-9474-7488